

ZF 220 V

10° V-drive, remote mount marine transmission.

Description

- Reverse reduction marine transmission with hydraulically actuated multi-disc clutches .
- Suitable for high performance applications in luxury motoryachts, sport fishers, express cruisers etc .
- Robust design also withstands continuous duty in workboat applications .
- Fully works tested, reliable and simple to install .
- Design, manufacture and quality control standards comply with ISO 9001 .
- Compatible with all types of engines and propulsion systems, including waterjets and surface- piercing propellers, as applicable .

Features

- Lightweight and robust aluminum alloy casing (sea water resistant) .
- Case hardened and precisely ground gear teeth for long life and smooth running .
- Output shaft thrust bearing designed to take maximum propeller thrust astern and ahead .
- Smooth and reliable hydraulic shifting with control lever for attachment of push-pull cable .
- Suitable for twin engine installations (same ratio and torque capacity in ahead or astern mode) .
- Replaceable oil filter cartridge .
- Compact, space saving design; 10° vee-angle and beveloid gear .

Options

- Oil cooler complete with fittings and flexible oil hoses .
- Mounting brackets .
- Propeller shaft flange and coupling bolt sets .
- Classification by all major Classification Societies on request .
- Trolling valve for slow-speed drive .

ZF 220 V

Ratings

Pleasure Duty

	RATIOS		MAX. TORQUE		POWER/RPM		INPUT POWER CAPACITY						MAX. RPM
	'A' Pos	'B' Pos	Nm	ftlb	kW	hp	2300 rpm		2800 rpm		3200 rpm		
							kW	hp	kW	hp	kW	hp	
■	1.235	1.235	890	656	0.0932	0.1250	214	287	261	350	298	400	4500
■	1.533	1.533	890	656	0.0932	0.1250	214	287	261	350	298	400	4500
■	1.750*	1.750	890	656	0.0932	0.1250	214	287	261	350	298	400	4500
■	2.040	2.040	890	656	0.0932	0.1250	214	287	261	350	298	400	4500
■	2.455	2.455	817	603	0.0855	0.1147	197	264	240	321	274	367	4500

'A' POS = continuous running position (normally AHEAD). 'B' POS = reverse position.

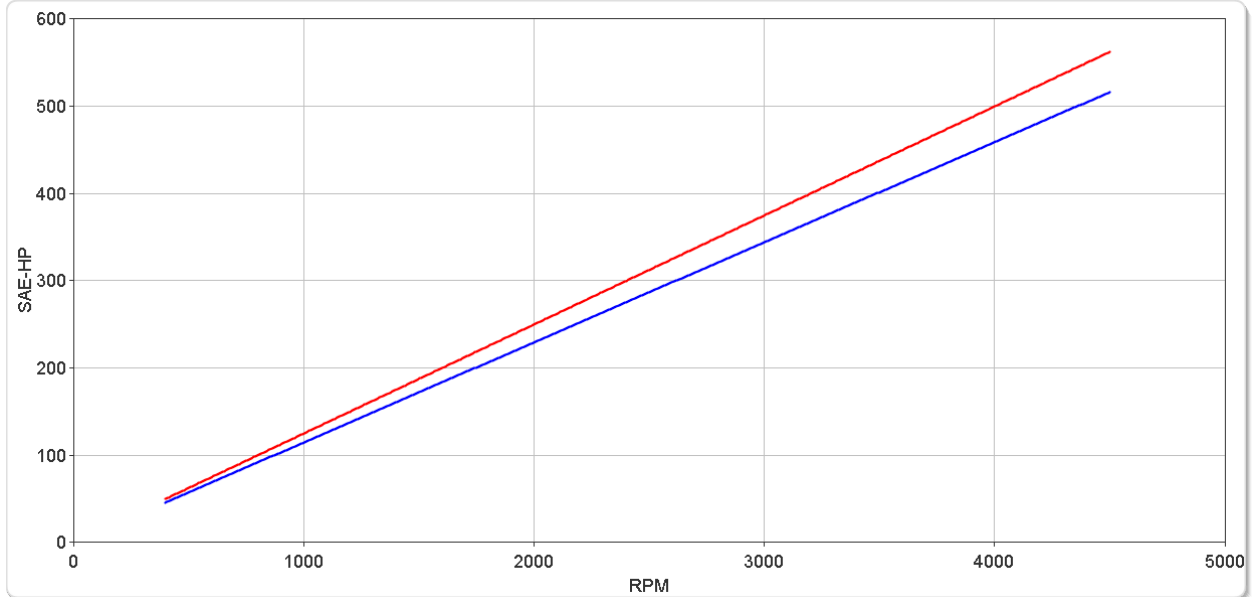
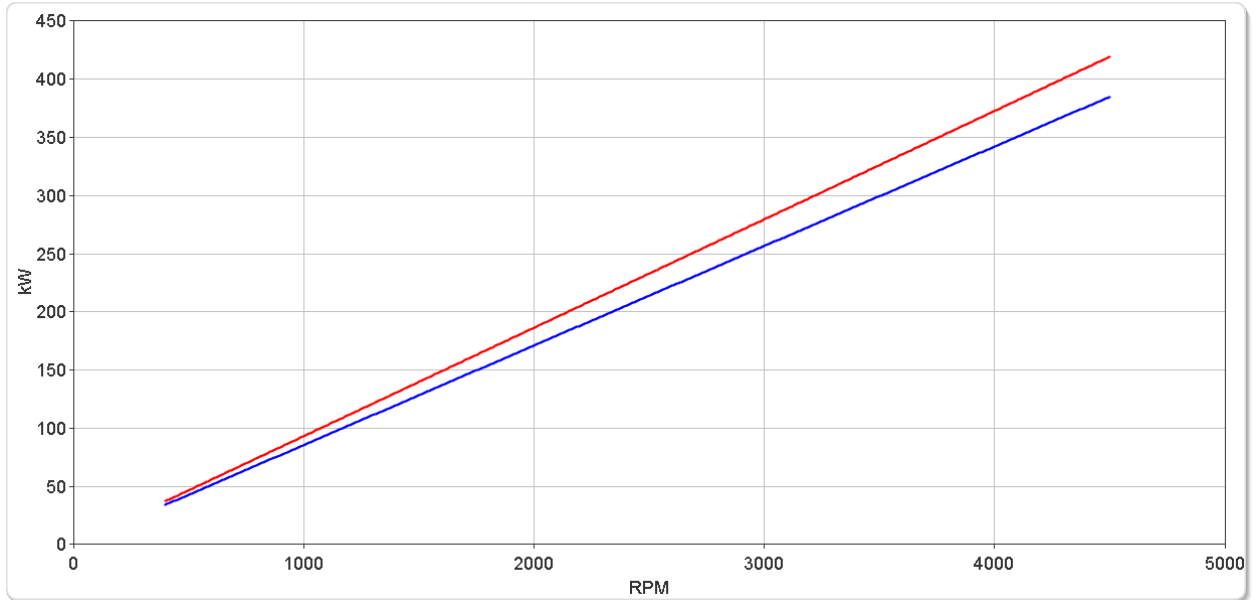

ZF 220 V

Ratings

Light Duty

	RATIOS		MAX. TORQUE		POWER/RPM		INPUT POWER CAPACITY						MAX. RPM
	'A' Pos	'B' Pos	Nm	ftlb	kW	hp	2100 rpm		2500 rpm		2800 rpm		
							kW	hp	kW	hp	kW	hp	
■	1.235	1.235	838	618	0.0877	0.1177	184	247	219	294	246	329	4500
■	1.533	1.533	838	618	0.0877	0.1177	184	247	219	294	246	329	4500
■	1.750*	1.750	838	618	0.0877	0.1177	184	247	219	294	246	329	4500
■	2.040	2.040	838	618	0.0877	0.1177	184	247	219	294	246	329	4500
■	2.455	2.455	754	556	0.0790	0.1059	166	222	197	265	221	296	4500

'A' POS = continuous running position (normally AHEAD). 'B' POS = reverse position.

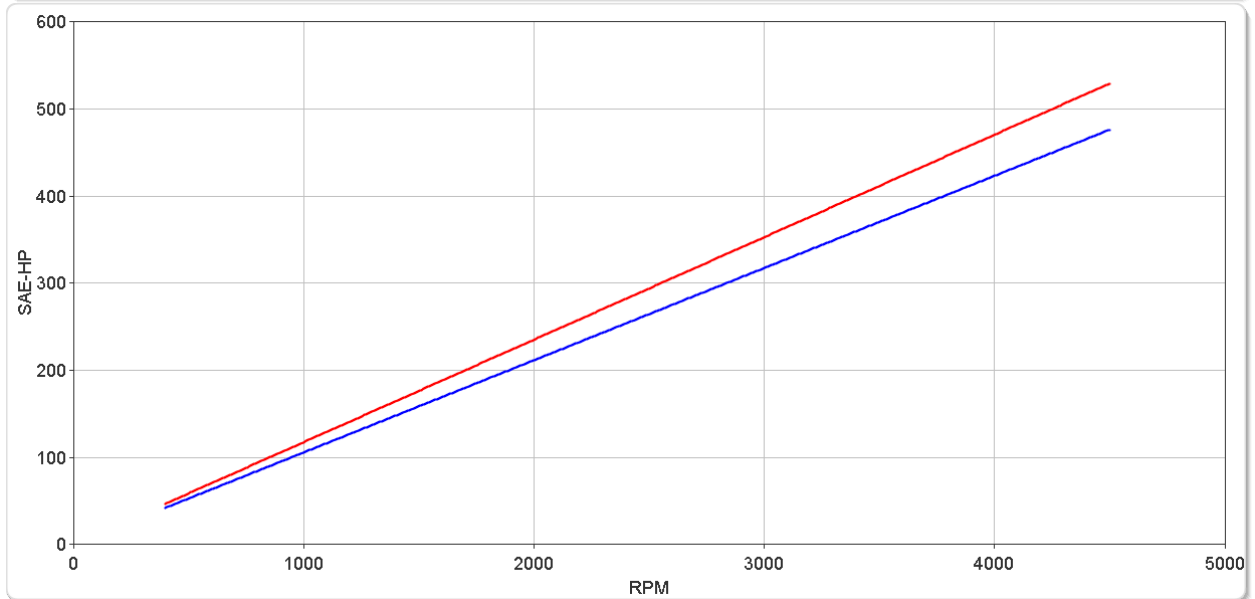
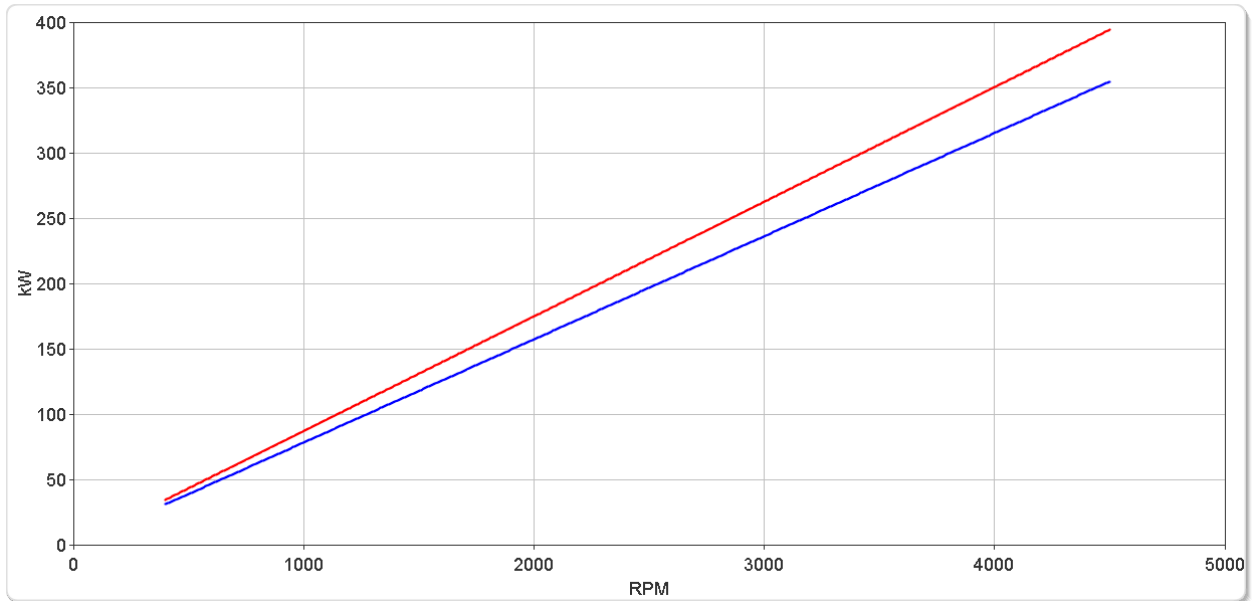

ZF 220 V

Ratings

Medium Duty

	RATIOS		MAX. TORQUE		POWER/RPM		INPUT POWER CAPACITY						MAX. RPM
	'A' Pos	'B' Pos	Nm	ftlb	kW	hp	2100 rpm		2500 rpm		2800 rpm		
							kW	hp	kW	hp	kW	hp	
■	1.235	1.235	712	525	0.0746	0.1000	157	210	186	250	209	280	4500
■	1.533	1.533	667	492	0.0698	0.0937	147	197	175	234	196	262	4500
■	1.750*	1.750	667	492	0.0698	0.0937	147	197	175	234	196	262	4500
■	2.040	2.040	667	492	0.0698	0.0937	147	197	175	234	196	262	4500
■	2.455	2.455	601	443	0.0629	0.0844	132	177	157	211	176	236	4500

'A' POS = continuous running position (normally AHEAD). 'B' POS = reverse position.

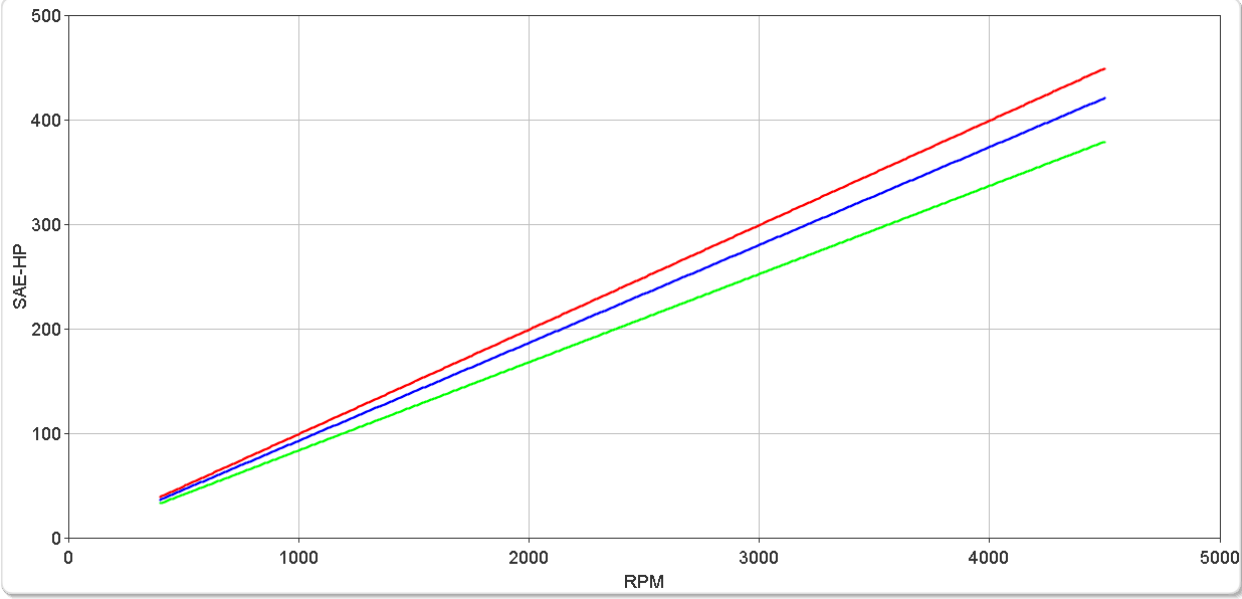
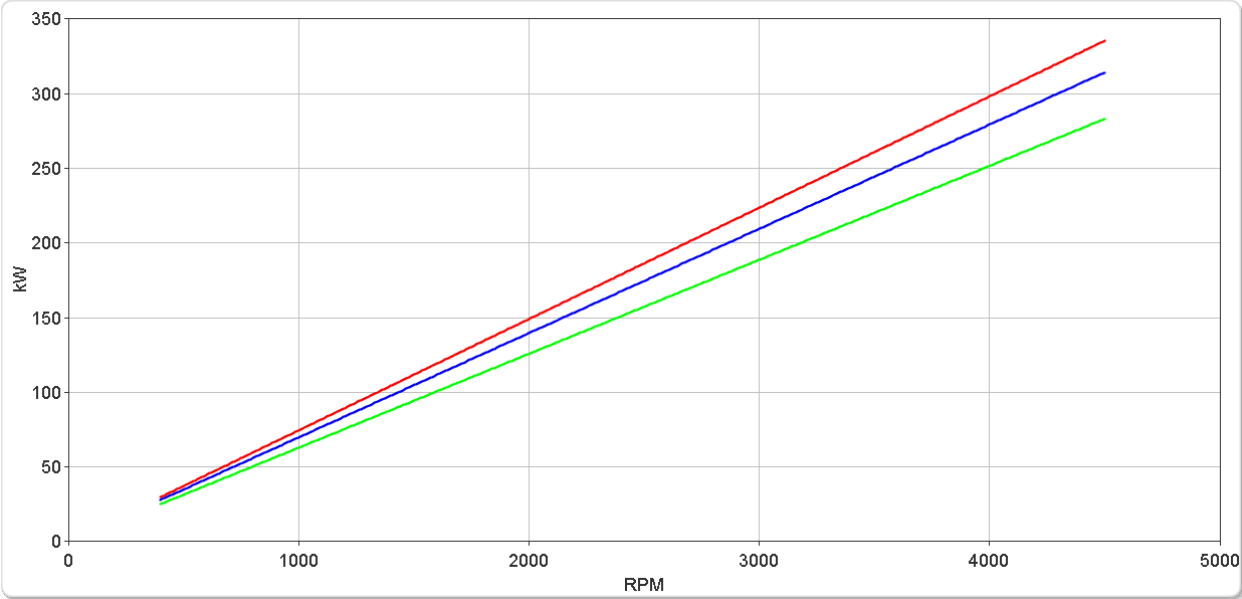

ZF 220 V

Ratings

Continuous Duty

	RATIOS		MAX. TORQUE		POWER/RPM		INPUT POWER CAPACITY						MAX. RPM
	'A' Pos	'B' Pos	Nm	ftlb	kW	hp	1800 rpm		2100 rpm		2300 rpm		
							kW	hp	kW	hp	kW	hp	
■	1.235	1.235	576	425	0.0603	0.0809	109	146	127	170	139	186	3200
■	1.533	1.533	555	409	0.0581	0.0779	105	140	122	164	134	179	3200
■	1.750*	1.750	555	409	0.0581	0.0779	105	140	122	164	134	179	3200
■	2.040	2.040	555	409	0.0581	0.0779	105	140	122	164	134	179	3200
■	2.455	2.455	500	369	0.0524	0.0702	94	126	110	147	120	161	3200

'A' POS = continuous running position (normally AHEAD). 'B' POS = reverse position.

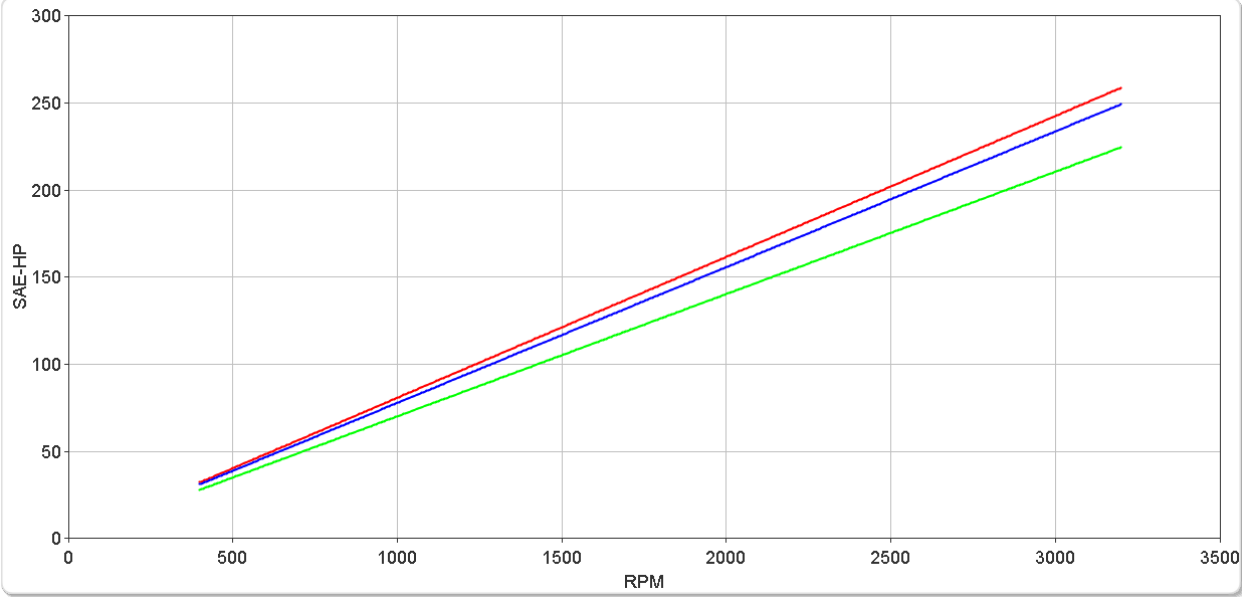
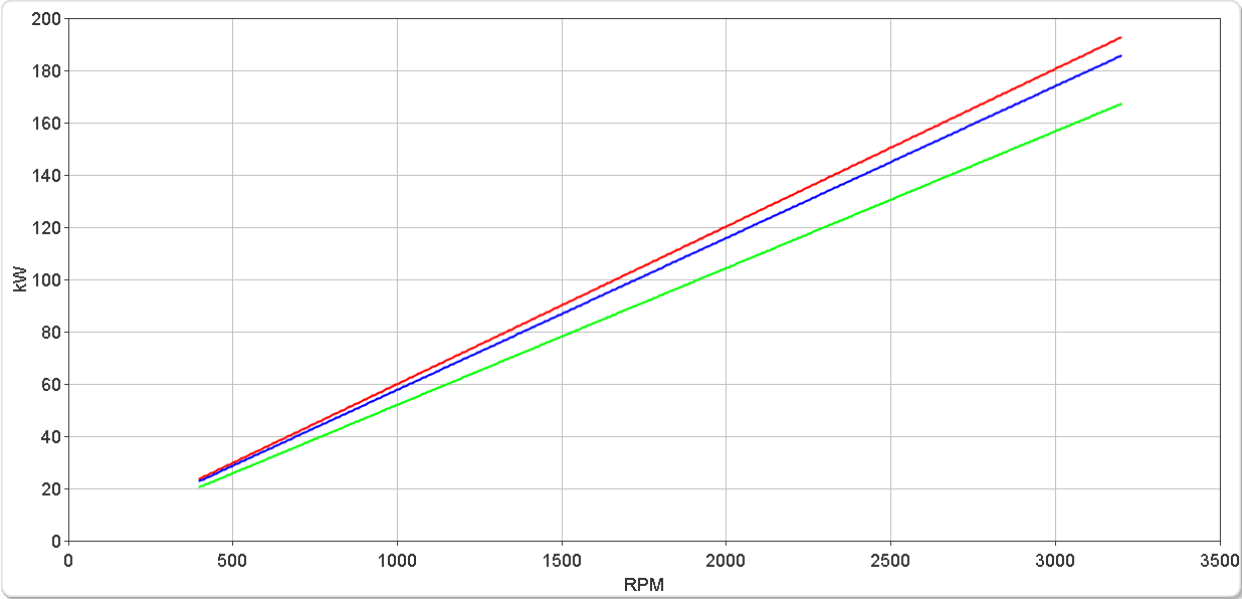

ZF 220 V

Dimensions

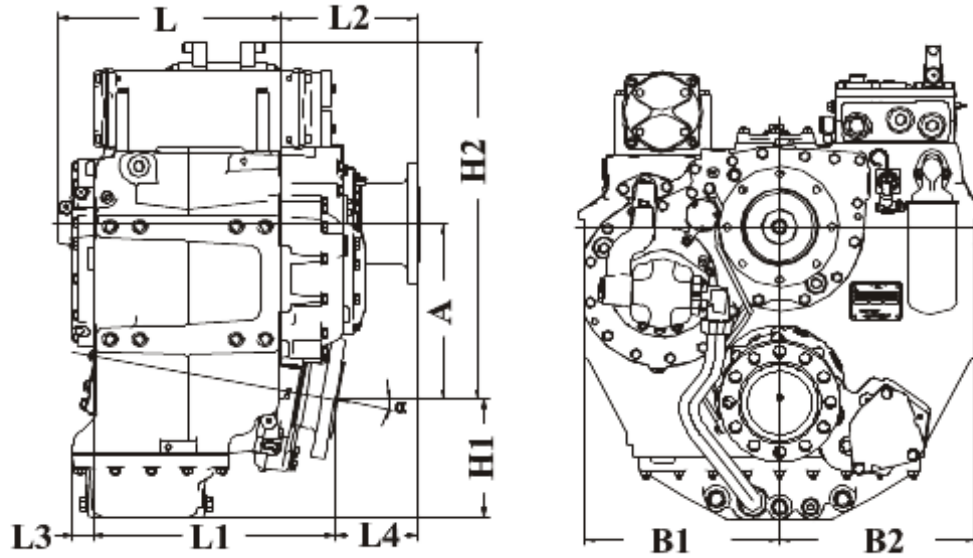

mm (inches)										
Angle	A	B ₁	B ₂	H ₁	H ₂	L	L ₁	L ₂	L ₃	L ₄
10.0	145 (5.69)	187 (7.38)	187 (7.38)	115 (4.55)	231 (9.09)	250 (9.84)	246 (9.70)	105 (4.13)	-	104 (4.08)
Weight kg (lb)						Oil Capacity Litre (US qt)				
65.0 (143)						4.00 (4.20)				

Output Coupling Dimensions

A		B		C		D		No.	Bolt Holes Diameter (E)	
mm	in	mm	in	mm	in	mm	in		mm	in
121	4.76	98.4	3.87	63.5	2.50	15.0	0.59	6	12.0	0.47

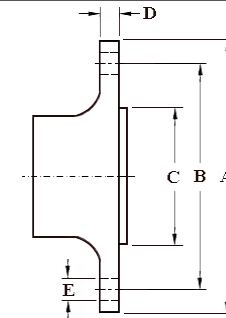

Duty Definitions

PLEASURE DUTY DEFINITION	Highly intermittent operation with very large variations in engine speed and power
Average engine operating hours limit:	500 hours/year 300 hours/year for mechanical gearboxes
Typical hull forms:	Planing.
Typical applications:	Private, non-commercial, non-charter sport/leisure activities.
LIGHT DUTY DEFINITION	Intermittent operation with large variations in engine speed and power
Average engine operating hours limit:	2500 hours/year (for hydraulic gearboxes smaller than the ZF 650 series, 2000 hours/year).
Typical hull forms:	Planing and semi-displacement.
Typical applications:	Private and charter, sport/leisure activities, naval and police activities.
MEDIUM DUTY DEFINITION	Intermittent operation with some variations in engine speed and power
Average engine operating hours limit:	4000 hours/year. 3500 hours/year for gearboxes smaller than ZF 2000 series and workboat ZF W2700 series.
Typical hull forms:	Semi-displacement and displacement
Typical applications:	Charter and commercial craft (example: crew boats and fast ferries), and naval and police activities.
CONTINUOUS DUTY DEFINITION	Continuous operation with little or no variations in engine speed and power
Average engine operating hours limit:	Unlimited
Typical hull forms:	Displacement.
Typical applications:	Heavy duty commercial vessels, tugs, fishing boats.

Duty Ratings

Ratings apply to marine diesel engines at the indicated speeds. At other engine speeds, the respective power capacity (kW) of the transmission can be obtained by multiplying the Power/Speed ratio by the speed.

Approximate conversion factors:

1 kW = 1.36 metric hp

1 kW = 1.34 U.S. hp (SAE)

1 U.S. hp = 1.014 metric hp

1 Nm = 0.74 lb.ft.

Ratings apply to right hand turning engines, i.e. engines having counterclockwise rotating flywheels when viewing the flywheel end of the engine.

These ratings allow full power through forward and reverse gear trains, unless otherwise stated.

Contact your nearest ZF Sales and Service office for ratings applicable to gas turbines, gasoline (petrol) engines, as well as left hand turning engines, and marine transmissions for large horsepower capacity engines.

Ratings apply to marine transmissions currently in production or in development and are subject to change without prior notice.

NOTE: THE MAXIMUM RATED INPUT POWER MUST NOT BE EXCEEDED (SEE RESPECTIVE RATINGS IN THE TECHNICAL DATA SHEETS)

Safe Operating Notice

The safe operation of ZF products depends upon adherence to technical data presented in our brochures. Safe operation also depends upon proper installation, operation and routine maintenance and inspection under prevailing conditions and recommendations set forth by ZF. Damage to transmission caused by repeated or continuous emergency manoeuvres or abnormal operation is not covered under warranty. It is the responsibility of users and not ZF to provide and install guards and safety devices, which may be required by recognized safety standards of the respective country (e.g. for U.S.A. the Occupational Safety Act of 1970 and its subsequent provisions).

Monitoring Notice

The safe operation of ZF products depends upon adherence to ZF monitoring recommendations presented in our operating manuals, etc. It is the responsibility of users and not ZF to provide and install monitoring devices and safety interlock systems as may be deemed prudent by ZF. Consult ZF for details and recommendations.

Torsional Responsibility and Torsional Couplings

The responsibility for ensuring torsional compatibility rests with the assembler of the drive and driven equipment. ZF can accept no liability for gearbox noise caused by vibrations or for damage to the gearbox, the flexible coupling or to other parts of the drive unit caused by this kind of vibration. Contact ZF for further information and assistance. ZF recommends the use of a torsional limit stop for single engine powered boats, wherein loss of propulsion power can result in loss of control. It is the buyer's responsibility to specify this option, which can result in additional cost and a possible increase in installation length.

ZF can accept no liability for personal injury, loss of life, or damage or loss of property due to the failure of the buyer to specify a torsional limit stop. ZF selects torsional couplings on the basis of nominal input torque ratings and commonly accepted rated engine governed speeds. Consult ZF for details concerning speed limits of standard offering torsional couplings, which can be less than the transmission limit. Special torsional couplings may be required for Survey Society Ice Classification requirements.

